



BOSCH

Bosch Limited
Post Box No:3000
Hosur Road, Adugodi
Bangalore-560030
Karnataka, India
Tel +91 80 67524938
www.bosch.in
L85110KA1951PLC000761
Secretarial.corp@in.bosch.com

Corporate Relationship Department
BSE Limited
1st Floor, New Trading Ring
Rotunda Building
Phiroze Jeejeebhoy Towers
Dalal Street, Fort
Mumbai – 400 001
Scrip code:500530

The Manager
Listing Department
National Stock Exchange of India Ltd.
Exchange Plaza, C-1, Block G
Bandra-Kurla Complex
Bandra (E)
Mumbai – 400 051
Scrip code: BOSCHLTD

31.05.2023

Dear Sir/Madam,

Sub: Regulation 30 of the Securities and Exchange Board of India (Listing Obligations and Disclosure Requirements) Regulation, 2015 – Presentation made to the Investors.

In pursuance of Regulation 30 of the Securities and Exchange Board of India (Listing Obligations and Disclosures Requirements) Regulations, 2015 and in continuation of our earlier letter dated May 30, 2023 intimating schedule of Annual Investor Meet convened on May 31,2023, please find attached Presentation made thereat. The presentation can also be accessed on the Company's website i.e. www.bosch.in

This is for your information and records.

Thanking you,

**Yours Sincerely,
for Bosch Limited,**

**V Srinivasan
Company Secretary & Compliance Officer**

"The contents of this presentation are for information purposes only and for the reader's personal non-commercial use. The contents are intended, but not guaranteed, to be correct, complete, or absolutely accurate. This presentation also contains forward-looking statements based on the currently held beliefs and assumptions of the management of the Company, which are expressed in good faith and, in their opinion, are reasonable. Forward-looking statements involve known and unknown risks, contingencies, uncertainties, market conditions and other factors, which may cause the actual results, financial condition, performance, or achievements of the Company or industry results, to differ materially from the results, financial condition, performance or achievements expressed or implied by such forward-looking statements. The Company does not make any representation, warranty or prediction that the results anticipated by such forward looking statements will be achieved. Neither the Company nor its affiliates or advisors or representatives nor any of their respective affiliates or any such person's officers or employees guarantees that the assumptions underlying such forward looking statements or management estimates are free from errors and the Company disclaims any obligation or liability to any person for any loss or damage caused by errors or omissions, whether arising from negligence, accident or any other cause. A multitude of factors including, but not limited to, changes in demand, competition, technology, the effect of COVID 19 in India and globally, and any macroeconomic conditions in India and globally can cause actual events, performance or results to differ significantly from any anticipated development. Forward looking statements speak only as of the date of this presentation and are not guarantees of future performance. As a result, the Company expressly disclaims any obligation or undertaking to release any update or revisions to any forward looking statements in this presentation as a result of any change in expectations or any change in events, conditions, assumptions or circumstances on which these forward looking statements are based. Given these uncertainties and other factors, viewers of this presentation are cautioned not to place undue reliance on these forward looking statements and management estimates. Recipients of this presentation are not to construe its contents, or any prior or subsequent communications from or with the Company or its representatives as investment, legal or tax advice. In addition, this presentation does not purport to be all inclusive or to contain all of the information that may be required to make a full analysis of the Company or the proposed transaction. Recipients of this presentation should each make their own evaluation of the Company and of the relevance and adequacy of the information and should make such other investigations as they deem necessary. This presentation is not a prospectus, a statement in lieu of a prospectus, an offering circular, an offering memorandum, an advertisement, an offer or an offer document under the Companies Act, 2013, the Securities and Exchange Board of India (Issue of Capital and Disclosure Requirements) Regulations, 2018, as amended, or any other applicable law in India. This presentation does not constitute or form part of and should not be construed as, directly or indirectly, any offer or invitation or inducement to sell or issue or an offer, or any solicitation of any offer, to purchase or sell any securities nor shall it or any part of it or the fact of its distribution form the basis of, or be relied on in connection with, any contract or commitment therefor. This presentation does not solicit any action based on the material contained herein. This presentation should not be considered as a recommendation that any person should subscribe for or purchase any securities of Bosch Limited and should not be used as a basis for any investment decision. This presentation has not been approved and will not or may not be reviewed or approved by any statutory or regulatory authority in India or by any stock exchange in India. This presentation does not purport to be a complete description of the markets conditions or developments referred to in the material. The information contained in this presentation is only current as of its date, unless specified otherwise, and has not been independently verified. Please note that, you will not be updated in the event the information in the presentation becomes stale. You must make your own assessment of the relevance, accuracy and adequacy of the information contained in this presentation and must make such independent investigations as you may consider necessary or appropriate for such purpose. Moreover, no express or implied

representation or warranty is made as to, and no reliance should be placed on, the accuracy, fairness or completeness of the information presented or contained in this presentation. None of the Company, its directors, promoter or affiliates, nor any of its or their respective employees, advisers or representatives or any other person accepts any responsibility or liability whatsoever, whether arising in tort, contract or otherwise, for any errors, omissions or inaccuracies in such information or opinions or for any loss, cost or damage suffered or incurred howsoever arising, directly or indirectly, from any use of this presentation or its contents or otherwise in connection with this presentation, and makes no representation or warranty, express or implied, for the contents of this presentation including its accuracy, fairness, completeness or verification or for any other statement made or purported to be made by any of them, or on behalf of them. Further, past performance is not necessarily indicative of future results. Any opinions expressed in this presentation or the contents of this presentation are subject to change without notice. The presentation should not be construed as legal, tax, investment or other advice. **THIS ANNOUNCEMENT AND/OR PRESENTATION IS NOT FOR DISTRIBUTION, DIRECTLY OR INDIRECTLY, IN OR INTO THE UNITED STATES OF AMERICA (the "U.S.>").** This announcement does not constitute nor form part of any offer or invitation to sell, issue or subscribe for securities in the U.S. or any other jurisdiction. No securities have been or will be registered under the U.S. Securities Act of 1933, as amended (the "Securities Act") or the securities laws of any state of the U.S. or any other jurisdiction. No securities may be offered, sold or delivered in the U.S. except pursuant to an exemption from, or in a transaction not subject to, the registration requirements of the Securities Act and applicable state or local securities laws. No public offering is being made in the U.S. or in any other jurisdiction where such an offering is restricted or prohibited or where such offer would be unlawful. Neither this announcement nor any portion hereof may be sent or transmitted into the U.S. or any jurisdiction where it is unlawful to do so. Any failure to comply with these restrictions may result in a violation of the Securities Act or the applicable laws of other jurisdictions. No money, securities or other consideration is being solicited by this announcement or the information contained herein and, if sent in response to this announcement or the information contained herein, will not be accepted. The extract(s), reconciliations or the explanation(s) provided in this presentation has been prepared only for illustrative purposes and the Company does not (i) hereby commit in any form that these differences will exist in subsequent periods, or (ii) necessarily intend to provide this in future. Bosch Limited or any of its affiliates, advisers or representatives accepts any liability whatsoever for any loss howsoever arising from any information presented or contained in this presentation. Furthermore, no person is authorized to give any information or make any representation which is not contained in, or is inconsistent with, this presentation. Any such extraneous or inconsistent information or representation, if given or made, should not be relied upon as having been authorized by or on behalf of the Bosch Limited. This presentation is strictly confidential and may not be copied or disseminated, reproduced, re-circulated, re-distributed, published or advertised in any media, website or otherwise, in whole or in part, and in any manner or for any purpose. Any unauthorized use, disclosure or public dissemination of information contained herein is prohibited. No person is authorized to give any information or to make any representation not contained in or inconsistent with this presentation and if given or made, such information or representation must not be relied upon as having been authorized by any person. Failure to comply with this restriction may constitute a violation of the applicable securities laws. The distribution of this presentation in certain jurisdictions may be restricted by law. Accordingly, any persons in possession of this presentation should inform themselves about and observe any such restrictions. By reviewing this presentation, you agree to be bound by the foregoing limitations. By accessing this presentation, you accept that this disclaimer and any claims arising out of the use of the information from this presentation shall be governed by the laws of India and only the courts in Bangalore, India and no other courts, shall have jurisdiction over the same."

BOSCH LTD. INVESTOR PRESENTATION

B&K Conference May 2023

31st May, 2023 | Mumbai



Press Conference
August, 14

Common F
1st June, 2006
Bangalore Plant

Motor Industries Company Limited
is now
Bosch Limited.



BOSCH
Invented for life

GDC 34M
PROFESSIONAL

MICO
Application Center



Investor Meet 2023 | Bosch Ltd.

Bosch Ltd. Executive Management



Guruprasad Mudlapur
Joint Managing Director &
Chief Technology Officer,
Bosch Ltd.



Karin Gilges
Chief Financial Officer,
Bosch Ltd.

Investor Meet 2023 | Bosch Ltd.

Macro Economic Impact on Business post Covid-19

Recession probabilities across the globe, interest rate hikes



US Bank failures pose risk to growth; Indian banks healthy balance sheet



India not immune to global slowdown: Muted Growth

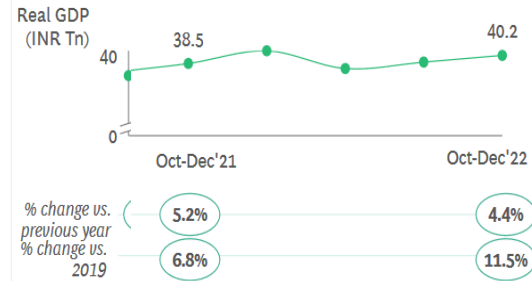

Global slowdown has led to export reduction for India



Govt. focus on Capex bodes well for India's growth



WPI and CPI eased slightly; still outside RBI's 6% band



Manufacturing & Services PMI remained in expansion

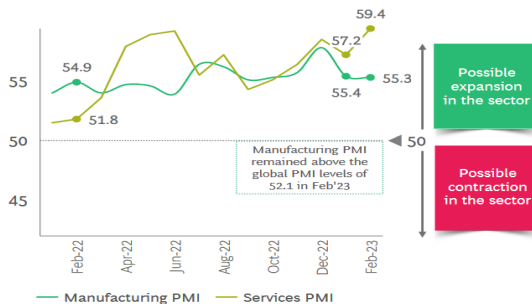

Election vs Economy



India is an Oasis in the Global Desert till now, but sandstorm is still blowing

Investor Meet 2023 | Bosch Ltd.

Indian Automotive market prognosis | Mid and Long Term

ICE Volumes in '000
EV Volumes in '000
H2 Volumes in '000

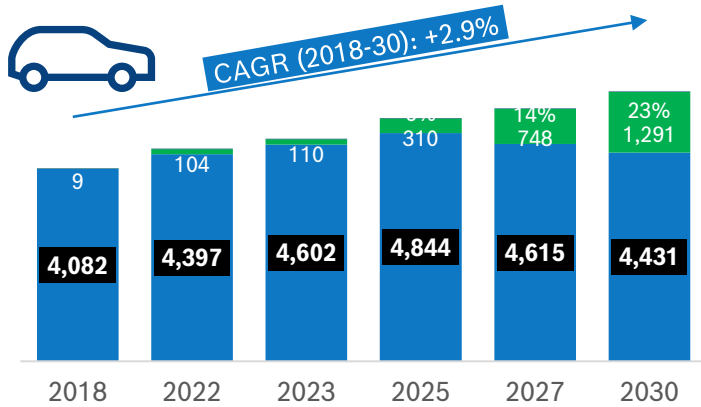

High % of BEV in 2030 driven by TCO & Infra development

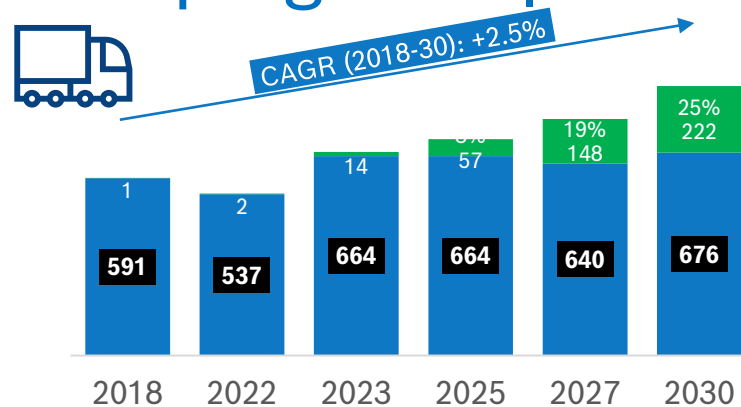

EV penetration mainly in < 2T LCVs | Last mile TCO benefit

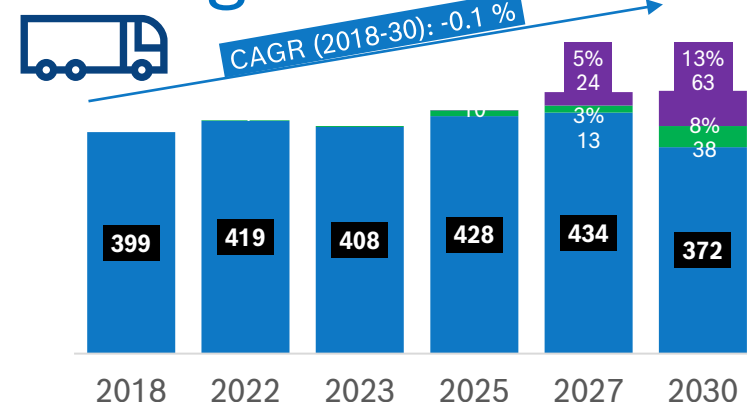

Long haul fleets will be part of the hydrogen ecosystem

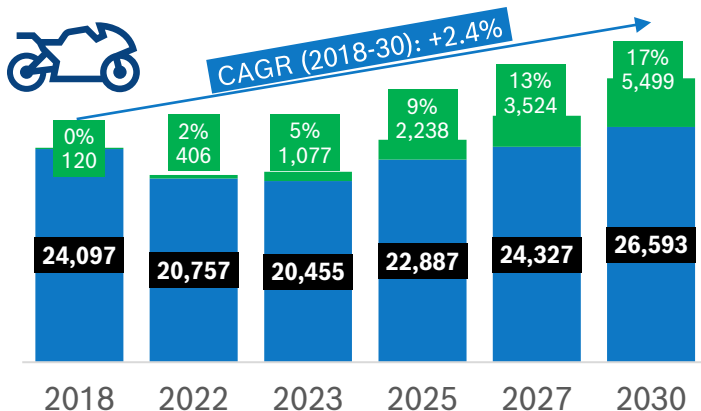

EV Adoption driven by PMPs and reducing battery prices

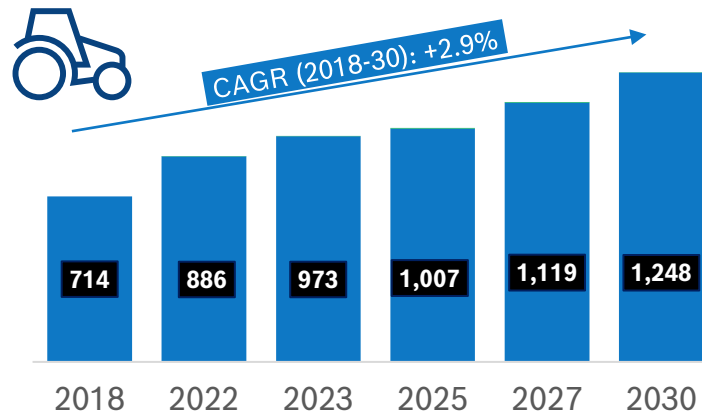

Steady growth over long term | TREM V delay possible

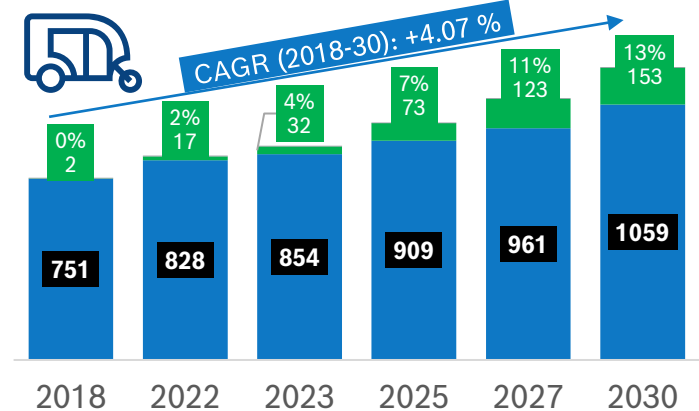

EV adoption led by TCO parity and new business models

Overall market expected to grow annually at 2-3% long term

Investor Meet 2023 | Bosch Ltd.

Bosch Mobility Revenue Has Been Growing Faster Than Market

- Successful implementation of BS6-OBD2 for On-road vehicles
- Focus in execution of TREM5 for Off-HW market
- Grow in Alternate fuel technology
- Overall, Sustain market leadership in ICE business

Majority of Present Core STP of 2029 is already booked in 2022

Acquisitions are in a right direction; Majority of acquisition's (99%) are from Present Core

Businesses are equally distributed between market segments

Bosch Electrified Powertrain – Product portfolio

Our global technology and platform covers 48V to 850V

Power drive

Energy management & supply

System control

HV



Electric Motor



eAxles

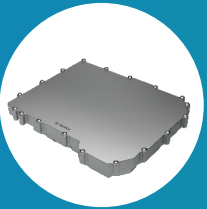

Inverter

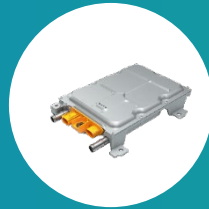

DC/DC Converter

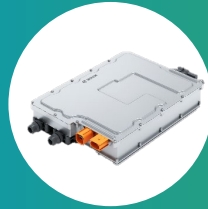

Charger-Converter



Fuel cell

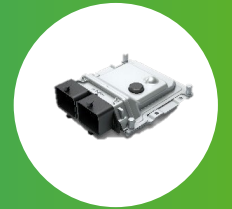

Vehicle Control Unit

48V

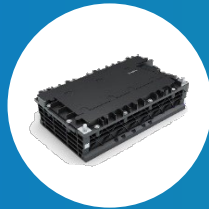

48V Traction Battery

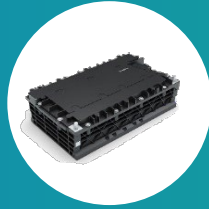

48V Hybrid Battery



48 V – 850 V

Investor Meet 2023 | Bosch Ltd.

Hydrogen based Powertrain Solutions by Bosch

Complete H₂-Engine System, Fuel Cell Electric System and Tank System

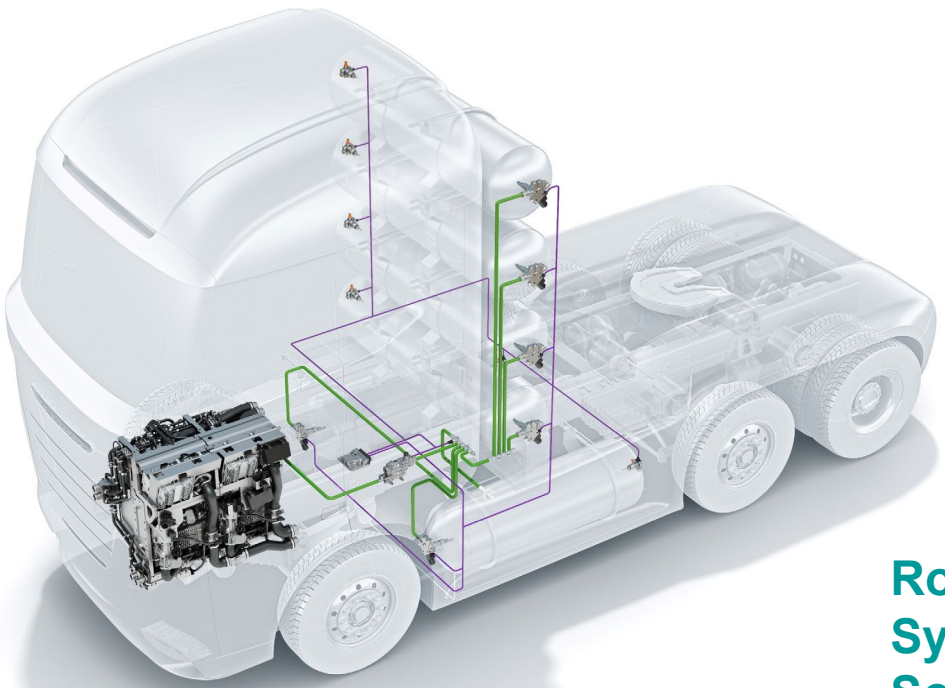

End-to-End Engineering Services

Robust Control Systems and Software

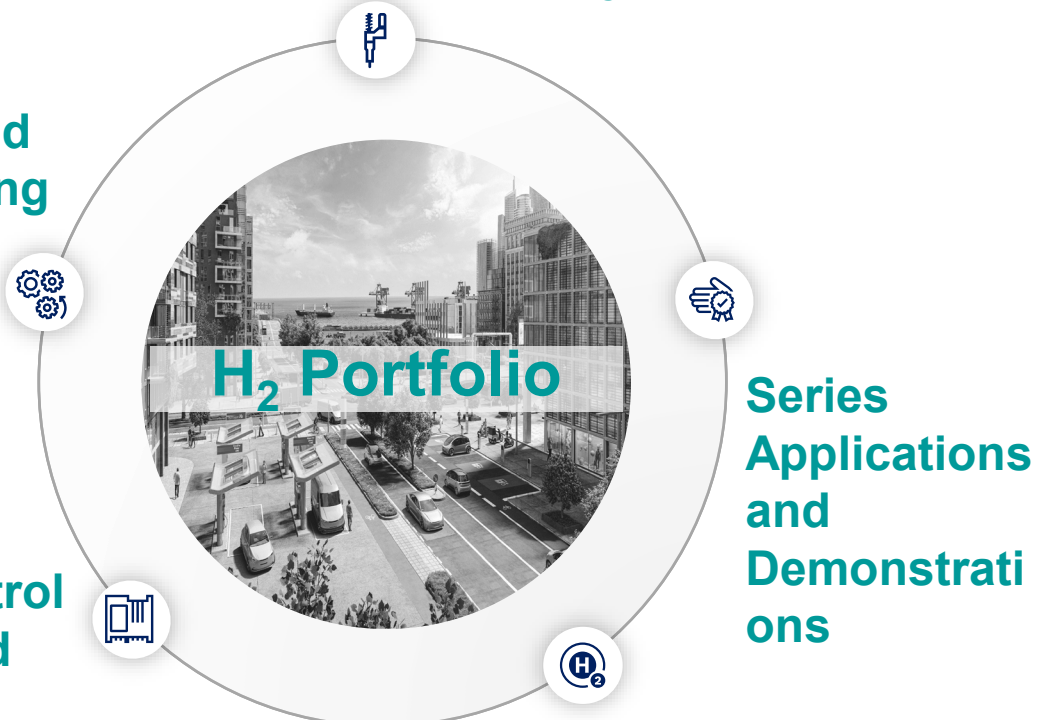

Series Applications and Demonstrations

State-of-the art H₂-E and FCEV Testing Infrastructure

Investor Meet 2023 | Bosch Ltd.

Diversifying Beyond Mobility



Automotive After market

- Portfolio Expansion
- Expansion of Bosch Car Service and 2W service
- Marketplace expansion



Power Tools

- Cordless (broaden portfolio)
- eMPP (mid price point)
- Local engineering
- Retail expansion
- D2U – eShop



Building Technologies

- Focus on Localisation
- Portfolio expansion – MPP (mid price point) segment

Diversified Portfolio: Achieve ~850 m Euro Long Term

Next Up



Karin Gilges
Chief Financial Officer, Bosch Ltd., India

Bosch Limited | Annual Investor Meet - 2023

Review of FY2022-23: BOSCH LIMITED

Reached Highest TNS for Bosch Ltd

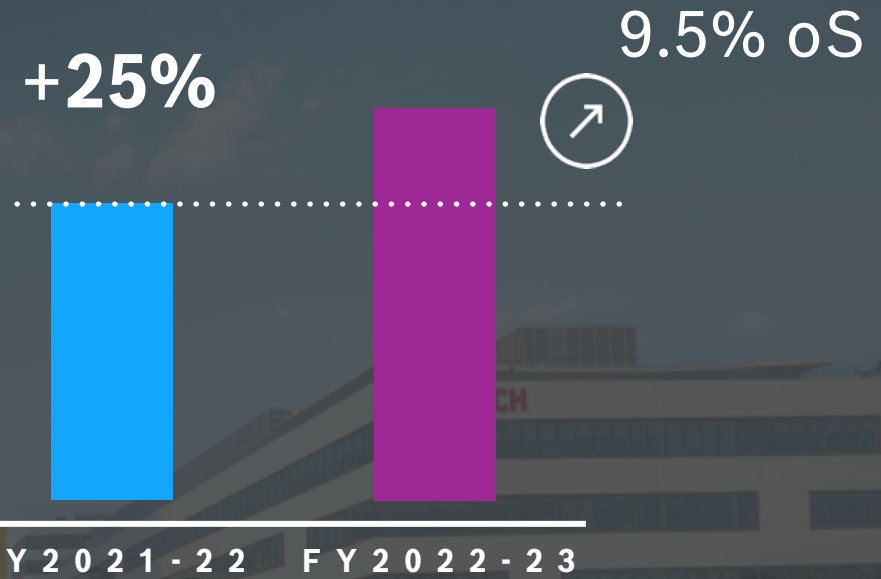
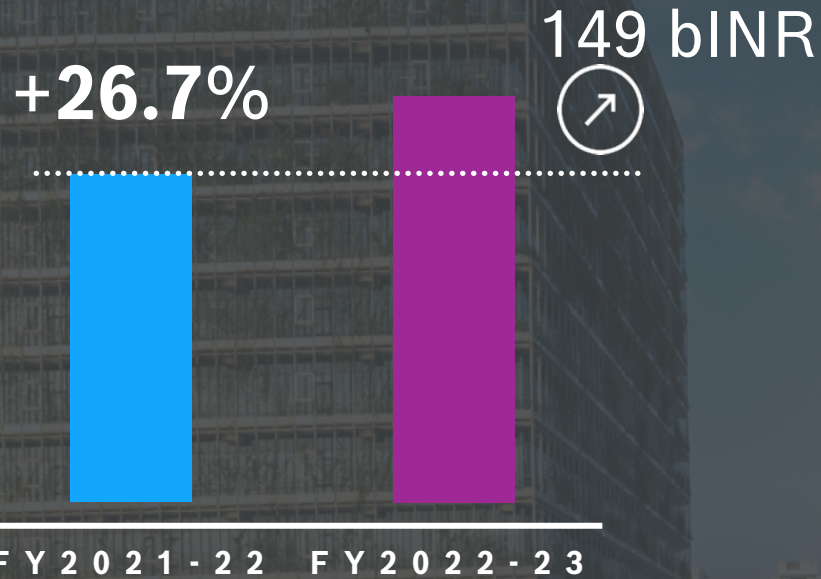

Research and Development cost

4.2 bINR



Capital Expenditure

6.7 bINR



Bosch Limited | Annual Investor Meet - 2023

Continue double digit growth

Outlook for 2023



Sales growth forecast more than **15%**



Research and development cost **4.8 bINR**



Driving towards healthy **EBIT margin**



Capital expenditure **4.8 bINR**



Bosch On the way to a

NEW ERA OF MOBILITY

Thank you..!