

"The contents of this presentation are for information purposes only and for the reader's personal non-commercial use. The contents are intended, but not guaranteed, to be correct, complete, or absolutely accurate. This presentation also contains forward-looking statements based on the currently held beliefs and assumptions of the management of the Company, which are expressed in good faith and, in their opinion, are reasonable. Forward-looking statements involve known and unknown risks, contingencies, uncertainties, market conditions and other factors, which may cause the actual results, financial condition, performance, or achievements of the Company or industry results, to differ materially from the results, financial condition, performance or achievements expressed or implied by such forward-looking statements. The Company does not make any representation, warranty or prediction that the results anticipated by such forward looking statements will be achieved. Neither the Company nor its affiliates or advisors or representatives nor any of their respective affiliates or any such person's officers or employees guarantees that the assumptions underlying such forward looking statements or management estimates are free from errors and the Company disclaims any obligation or liability to any person for any loss or damage caused by errors or omissions, whether arising from negligence, accident or any other cause. A multitude of factors including, but not limited to, changes in demand, competition, technology, the effect of COVID 19 in India and globally, and any macroeconomic conditions in India and globally can cause actual events, performance or results to differ significantly from any anticipated development. Forward looking statements speak only as of the date of this presentation and are not guarantees of future performance. As a result, the Company expressly disclaims any obligation or undertaking to release any update or revisions to any forward looking statements in this presentation as a result of any change in expectations or any change in events, conditions, assumptions or circumstances on which these forward looking statements are based. Given these uncertainties and other factors, viewers of this presentation are cautioned not to place undue reliance on these forward looking statements and management estimates. Recipients of this presentation are not to construe its contents, or any prior or subsequent communications from or with the Company or its representatives as investment, legal or tax advice. In addition, this presentation does not purport to be all inclusive or to contain all of the information that may be required to make a full analysis of the Company or the proposed transaction. Recipients of this presentation should each make their own evaluation of the Company and of the relevance and adequacy of the information and should make such other investigations as they deem necessary. This presentation is not a prospectus, a statement in lieu of a prospectus, an offering circular, an offering memorandum, an advertisement, an offer or an offer document under the Companies Act, 2013, the Securities and Exchange Board of India (Issue of Capital and Disclosure Requirements) Regulations, 2018, as amended, or any other applicable law in India. This presentation does not constitute or form part of and should not be construed as, directly or indirectly, any offer or invitation or inducement to sell or issue or an offer, or any solicitation of any offer, to purchase or sell any securities nor shall it or any part of it or the fact of its distribution form the basis of, or be relied on in connection with, any contract or commitment therefor. This presentation does not solicit any action based on the material contained herein. This presentation should not be considered as a recommendation that any person should subscribe for or purchase any securities of Bosch Limited and should not be used as a basis for any investment decision. This presentation has not been approved and will not or may not be reviewed or approved by any statutory or regulatory authority in India or by any stock exchange in India. This presentation does not purport to be a complete description of the markets conditions or developments referred to in the material. The information contained in this presentation is only current as of its date, unless specified otherwise, and has not been independently verified. Please note that, you will not be updated in the event the information in the presentation becomes stale. You must make your own assessment of the relevance, accuracy and adequacy of the information contained in this presentation and must make such independent investigation as you may consider necessary or appropriate for such purpose. Moreover, no express or implied

representation or warranty is made as to, and no reliance should be placed on, the accuracy, fairness or completeness of the information presented or contained in this presentation. None of the Company, its directors, promoter or affiliates, nor any of its or their respective employees, advisers or representatives or any other person accepts any responsibility or liability whatsoever, whether arising in tort, contract or otherwise, for any errors, omissions or inaccuracies in such information or opinions or for any loss, cost or damage suffered or incurred howsoever arising, directly or indirectly, from any use of this presentation or its contents or otherwise in connection with this presentation, and makes no representation or warranty, express or implied, for the contents of this presentation including its accuracy, fairness, completeness or verification or for any other statement made or purported to be made by any of them, or on behalf of them. Further, past performance is not necessarily indicative of future results. Any opinions expressed in this presentation or the contents of this presentation are subject to change without notice. The presentation should not be construed as legal, tax, investment or other advice. **THIS ANNOUNCEMENT AND/OR PRESENTATION IS NOT FOR DISTRIBUTION, DIRECTLY OR INDIRECTLY, IN OR INTO THE UNITED STATES OF AMERICA (the "U.S.>").** This announcement does not constitute nor form part of any offer or invitation to sell, issue or subscribe for securities in the U.S. or any other jurisdiction. No securities have been or will be registered under the U.S. Securities Act of 1933, as amended (the "Securities Act") or the securities laws of any state of the U.S. or any other jurisdiction. No securities may be offered, sold or delivered in the U.S. except pursuant to an exemption from, or in a transaction not subject to, the registration requirements of the Securities Act and applicable state or local securities laws. No public offering is being made in the U.S. or in any other jurisdiction where such an offering is restricted or prohibited or where such offer would be unlawful. Neither this announcement nor any portion hereof may be sent or transmitted into the U.S. or any jurisdiction where it is unlawful to do so. Any failure to comply with these restrictions may result in a violation of the Securities Act or the applicable laws of other jurisdictions. No money, securities or other consideration is being solicited by this announcement or the information contained herein and, if sent in response to this announcement or the information contained herein, will not be accepted. The extract(s), reconciliations or the explanation(s) provided in this presentation has been prepared only for illustrative purposes and the Company does not (i) hereby commit in any form that these differences will exist in subsequent periods, or (ii) necessarily intend to provide this in future. Bosch Limited or any of its affiliates, advisers or representatives accepts any liability whatsoever for any loss howsoever arising from any information presented or contained in this presentation. Furthermore, no person is authorized to give any information or make any representation which is not contained in, or is inconsistent with, this presentation. Any such extraneous or inconsistent information or representation, if given or made, should not be relied upon as having been authorized by or on behalf of the Bosch Limited. This presentation is strictly confidential and may not be copied or disseminated, reproduced, re-circulated, re-distributed, published or advertised in any media, website or otherwise, in whole or in part, and in any manner or for any purpose. Any unauthorized use, disclosure or public dissemination of information contained herein is prohibited. No person is authorized to give any information or to make any representation not contained in or inconsistent with this presentation and if given or made, such information or representation must not be relied upon as having been authorized by any person. Failure to comply with this restriction may constitute a violation of the applicable securities laws. The distribution of this presentation in certain jurisdictions may be restricted by law. Accordingly, any persons in possession of this presentation should inform themselves about and observe any such restrictions. By reviewing this presentation, you agree to be bound by the foregoing limitations. By accessing this presentation, you accept that this disclaimer and any claims arising out of the use of the information from this presentation shall be governed by the laws of India and only the courts in Bangalore, India and no other courts, shall have jurisdiction over the same."

BOSCH LTD. INVESTOR PRESENTATION

Quarterly Results December 2022

14th Feb, 2023 | Bengaluru



Bosch Ltd || Investor Con-call Q3 FY22-23

Production

Volumes in '000s

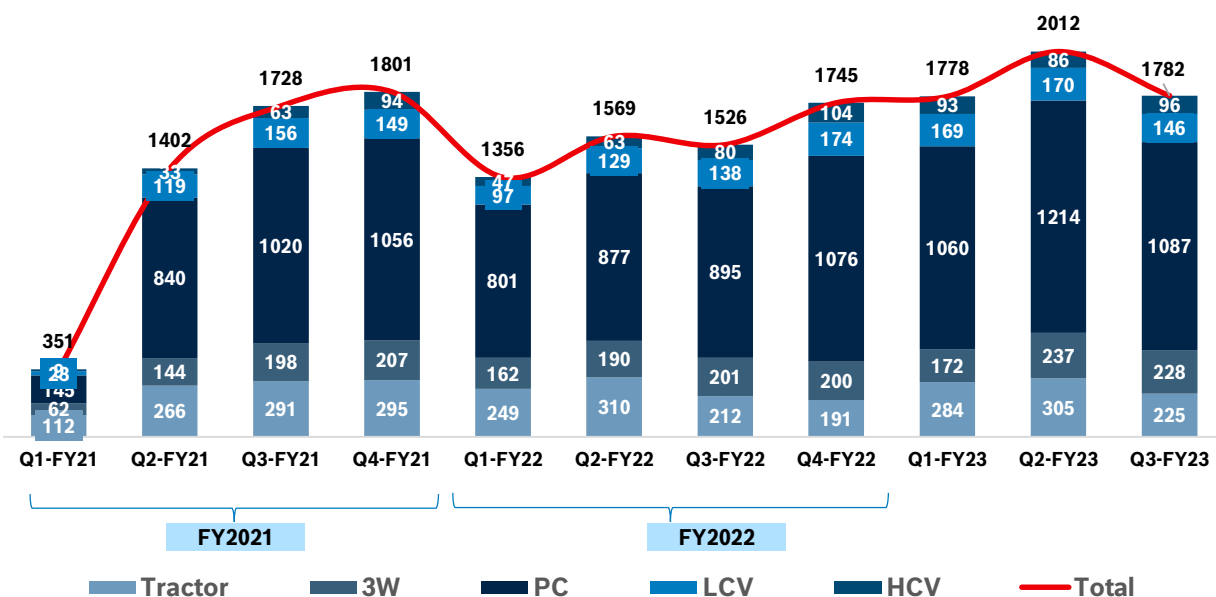

	FY2022-23 Q3		FY2022-23 YTD Q1-Q3		
	Volumes	%Change w. Q3-FY22	%Change w. Q2-FY23	Volumes	%Change w. Q1-Q3FY22
	96	+20%	+11%	276	+45%
	146	+5%	-14%	484	+32%
	1087	+21%	-10%	3360	+31%
	228	+14%	-4%	637	+15%
	225	+6%	-26%	814	+6%
Total	1782	+17%	-11%	5571	+25%
	4605	+1%	-18%	15076	+14%

Production Volumes In Q3FY23 Grew YoY Basis While Declined QoQ Basis Except For HCVs

Bosch Ltd || Investor Con-call Q3 FY22-23

Automotive market prognosis | Production outlook

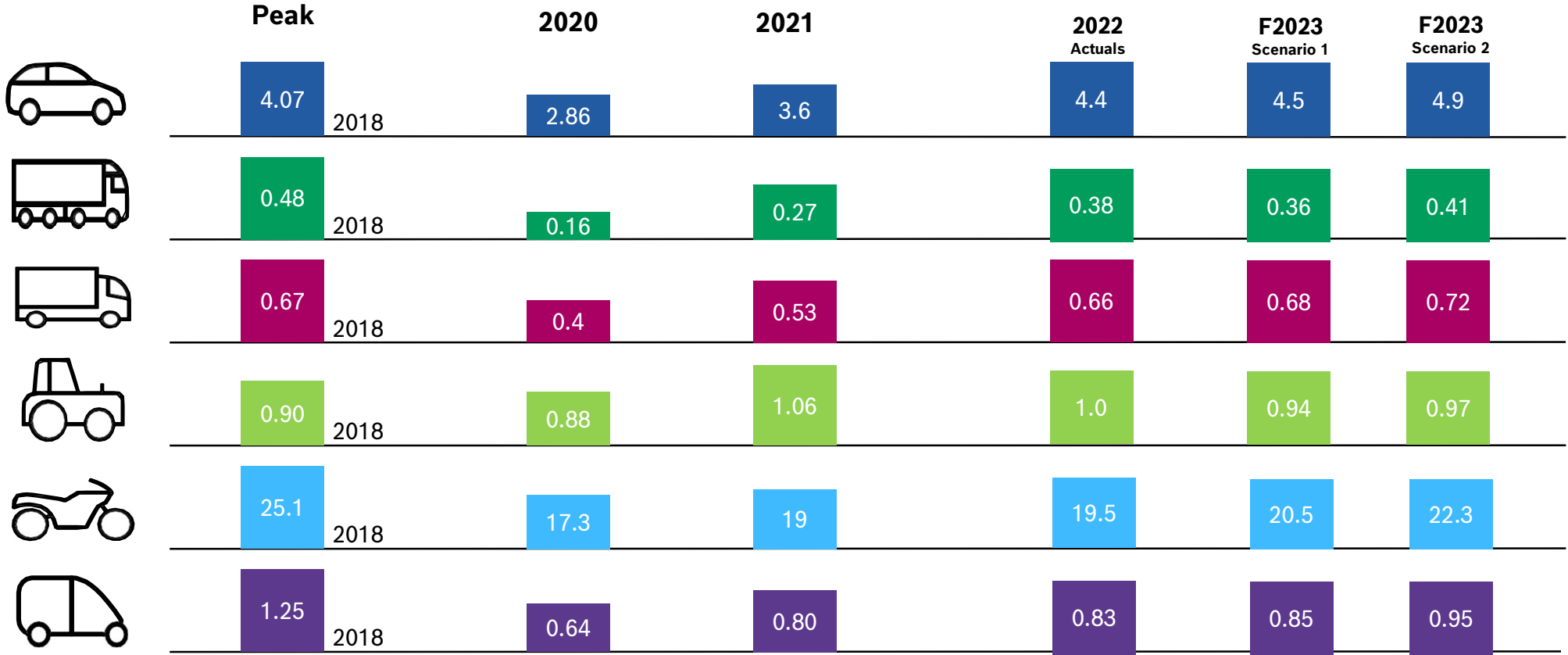

Unit of Measure in Mio vehicles

Bosch Ltd || Investor Con-call Q3 FY22-23

Sector Wise Sales Dec 2022 Q on Q

Figs. in MINR

Mobility Solutions (BBM)

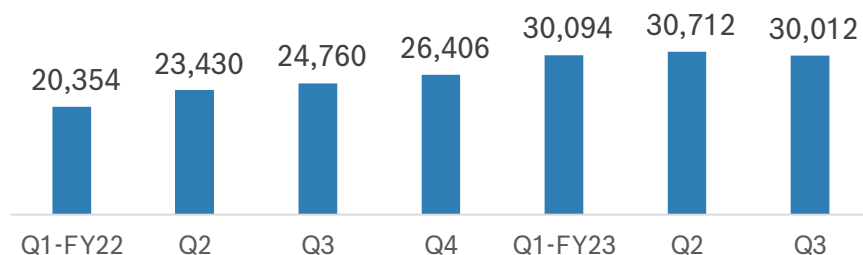

Consumer Goods (BBG)

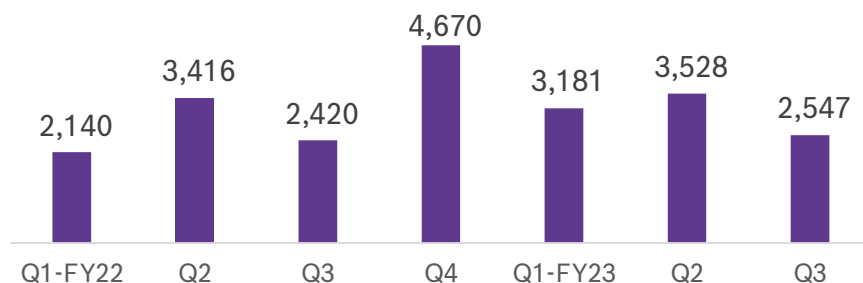

Energy & Building Technology (BBE)

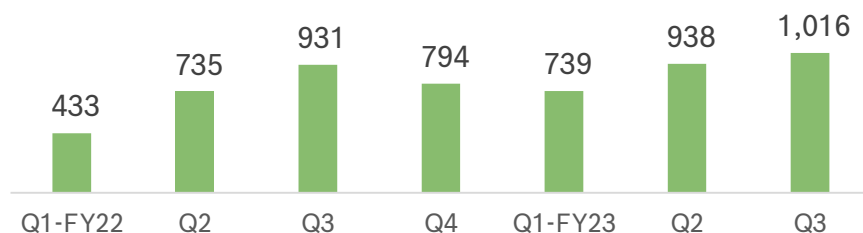

Mobility Solutions comprises of Powertrain Solutions (PS), Automotive Aftermarket (AA) and 2-Wheeler Business (2WP)

- Sales growth by 21.2% in Q3 FY 2022-23 vs Q3 FY 2021-22
- Growth driven by increase in sales of Power train Solutions +31.1% mainly due to improved market demand and positive consumer sentiment
- AA has marginally de-grown by 2.7%
- 2WP sales increased by 31.7% due to significant improvement in semi-conductor supplies in current quarter

Consumer goods comprises of Power Tools (PT)

- Consumer goods segment increased by 5.2% due to higher sales in accessories business

Energy & Building Technologies comprises of Security Technology (ST) & Energy Solutions

- Growth of 9.1% is driven by increased orders executed for (i) energy efficiency projects (relatively orders executed in 2021 were very low due to second wave of pandemic) and (ii) pick up in overall economic and business activities

Note: The above are total revenue from sale of products only. It does not include income from sale of services and other operating income.



Bosch Ltd || Investor Con-call Q3 FY22-23

Profitability Statement - Oct to Dec 2022 vs Oct to Dec 2021

FIGURES IN MILLION INR

	Oct-Dec 22		Oct-Dec 21		over PY
	Amount	%	Amount	%	%
Net Sales	33,797	92.3	28,438	91.5	18.8
Income from Services	1,701	4.6	2,028	6.5	(16.1)
Net Sales and Income from Operations	35,498	97.0	30,466	98.0	16.5
Other Operating Income	1,101	3.0	625	2.0	76.2
Total Income from Operations	36,599	100.0	31,091	100.0	17.7
Material Consumed	21,947	60.0	18,890	60.8	16.2
Personnel Cost	2,725	7.4	2,927	9.4	(6.9)
Other Expenses	7,890	21.6	5,700	18.3	38.4
Depreciation	1,083	3.0	851	2.7	27.3
Total Operating Expenses	33,645	91.9	28,368	91.2	18.6
Operating Profit	2,954	8.1	2,723	8.8	8.5
Other Income	1,312	3.6	804	2.6	63.3
Finance Cost	(20)	(0.1)	(169)	(0.5)	(88.0)
Profit before Exceptional Items	4,246	11.6	3,358	10.8	26.5
Exceptional Items	0	-	0	-	-
Profit before Tax	4,246	11.6	3,358	10.8	26.5
Total Tax Expense (% of PBT)	1,057	24.9	1,009	30.1	4.8
Profit after Tax	3,189	8.7	2,349	7.6	35.8

Growth in Total income from operations by +17.7% over same quarter of previous year

Material Cost

- Material cost as a percentage of total income from operations was on similar lines as compared to Oct-Dec 2021 due to actualization of 2022 year end closing inventory

Personnel Cost

- Oct-Dec 2021 comprised of certain employee related medical and welfare provisions, which were no longer required

Other expenses

- Increase in expenses is on account of certain one-time impacts (like foreign exchange loss, new business expenditure, etc.) and completion of R&D projects in Oct-Dec 2022

Depreciation

- Increase is on account of capitalization of Adegodi Spark.NXT campus in Jul-Sept 2022

Other Income

- Increased income is mainly on account of higher mark-to-market gain on mutual funds and higher FD int. income as compared to Oct-Dec 2021

Bosch Ltd || Investor Con-call Q3 FY22-23

Automotive Aftermarket Update

- From last 2Yrs, AA has embarked on a demand generation strategy called Zing+ which plans to increase distribution network through increased focus on Secondary, Tertiary customers
 - Highest ever TNS in 2022 with high EBIT
 - Industry benchmark on net working capital management at 23 days
 - Ramp up of Bosch Car Service network to 500 locations , 4th largest Car Service Network
 - Launch of “Bosch 2W service concept ”: Centre of competence globally for 2W workshops
 - 30% growth in Exports. Achieve growth by expanding untapped market and product range in Sri Lanka, Bangladesh and Nepal
- Aiming for strong double digit market share by 2024



Bosch Ltd || Investor Con-call Q3 FY22-23

Hydrogen based Powertrain Solutions by Bosch

Complete H₂-Engine System, Fuel Cell Electric System and Tank System

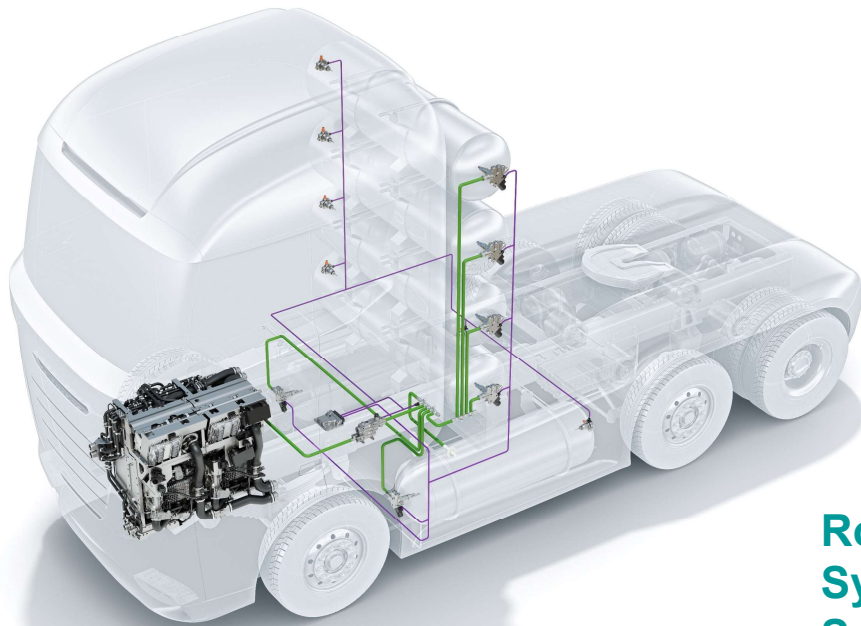

End-to-End Engineering Services

Robust Control Systems and Software

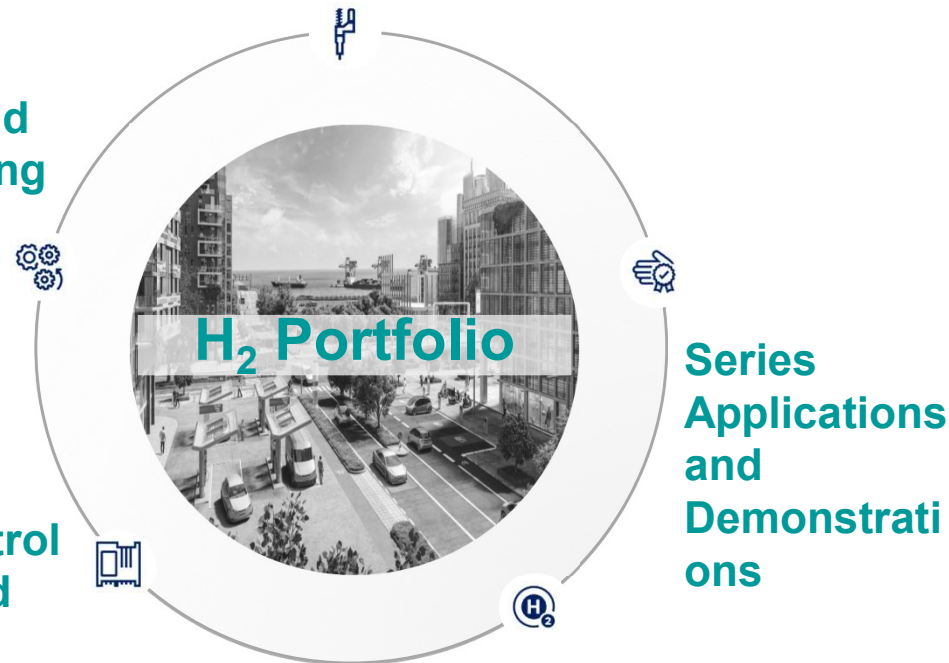

State-of-the art H₂-E and FCEV Testing Infrastructure



BOSCH

Invented for life



IT'S A HAT-TRICK!

**RBIN is now certified as a GREAT
PLACE TO WORK for the 3rd time
in a row!**



THANK YOU